

Dimensions

MOTOR ONLY

- MOTOR MODEL: 8DCD□-40-30

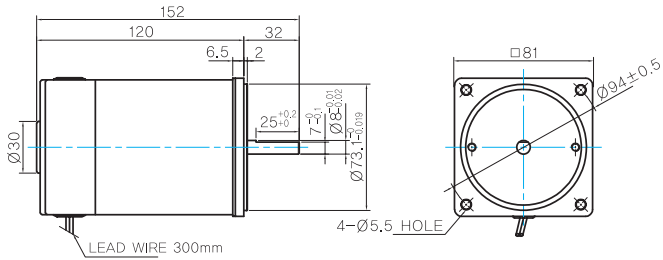

MOTOR OUTPUT SHAFT

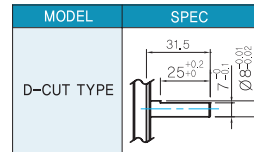

INTER-DECIMAL GEARBOX

- MODEL: 8XD10□□

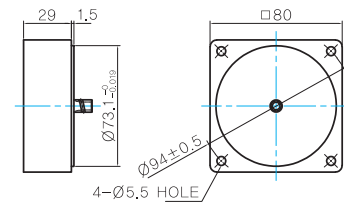

GEARED MOTOR

G TYPE GEARBOX

- MOTOR MODEL: 8DCG□-40-30

- GEARBOX MODEL: 8GBK□BMH

GEARBOX OUTPUT SHAFT

- 32(42.5)-Table1

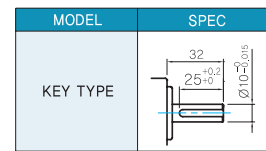
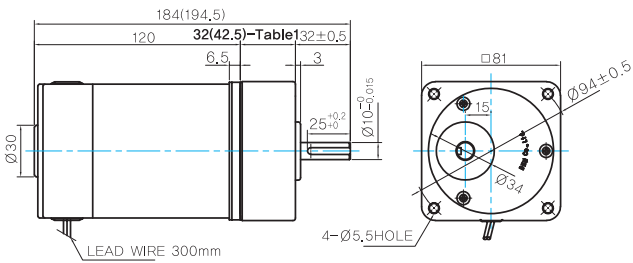

SIZE(mm)	GEAR RATIO
32	8GBK3BMH ~ 8GBK18BMH
42.5	8GBK25BMH ~ 8GBK360BMH

KEY SPEC

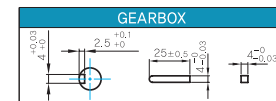

W TYPE GEARBOX

- MOTOR MODEL: 8DCW□-40-30

- GEARBOX MODEL: 8WD□BL/BR/BRL

KEY SPEC

WEIGHT

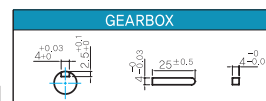
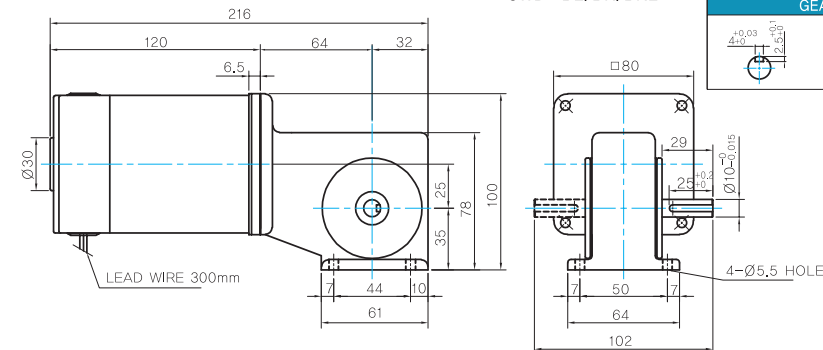

PART	WEIGHT(Kg)	
MOTOR	1.5	
GEAR BOX	8GBK3BMH ~ 8GBK18BMH	0.48
	8GBK25BMH ~ 8GBK30BMH	0.61
	8GBK36BMH ~ 8GBK180BMH	0.67
	8GBK200BMH ~ 8GBK360BMH	0.63
	8WD□BL/BR/BRL	0.67
	8XD10□□	0.44

Motor Images

