

Brake Motor 200W (□90mm)

200W Brake Motor 200W(□90mm)

Brake Motor 200W (□90mm)

Motor Specification

Model 9BDG*-200F□: Gear Type Shaft 9BDD*-200F: D-Cut Type Shaft 9BDK*-200F: Key Type Shaft	Output W	Voltage V	Frequency Hz	Poles	Duty	Starting Torque kgfcm N.m		Rated Load				Capacitor μF / VAC
								Speed r/min	Current A	Torque		
										kgfcm	N.m	
9BDGG-200F□	200	3φ220	50	4	Cont.	38.00	3.800	1300	1.40	15.00	1.500	-
			60					1550	1.20	13.00	1.300	
9BDGK-200F□	200	3φ380	50	4	Cont.	26.00	2.600	1300	0.69	15.00	1.500	-
			60					1550	0.61	12.80	1.280	
			50					1300	0.75	15.00	1.500	
		60	1600	0.60	12.20	1.220						
		3φ400					50	4	Cont.	30.00	3.000	
			60	1600	0.60	12.20	1.220					

1) Enter the phase & voltage code in the place * and enter the model type of attaching Gearbox in the box (□) within the motor model name.

2) All models contain a built-in thermal protector.

3) Gear Type Shaft is for attaching Gearbox and D-Cut & Key Type Shafts are for using motor only.

※ It is not possible to use inverter for three phase 380~440V motor. When inverter is used, the insulation of winding coil becomes hot and may cause damage to the motor.

Max. Permissible Torque at Output Shaft of Gearbox

60Hz

Motor Model	Gearbox Model	Gear Ratio	3	3.6	6	9	12.5	15	18	20	25	30	36	50	60	75	90	100	120	150	180	200	
			r/min	600	500	300	200	144	120	100	90	72	60	50	36	30	24	20	18	15	12	10	9
9BDG□ -200FH	9HBK□BH 9HFK□BH	kgfcm	32.4	38.8	64.7	97.1	121.9	146.3	175.5	176.8	221.0	265.2	300.0	300.0	300.0	300.0	300.0	300.0	300.0	300.0	300.0	300.0	300.0
		N.m	3.17	3.81	6.34	9.52	11.94	14.33	17.20	17.33	21.66	25.99	29.40	29.40	29.40	29.40	29.40	29.40	29.40	29.40	29.40	29.40	29.40

Motor Model	Gearbox Model	Gear Ratio	7.5	10	15	20	25	30	40	50	60	80	100
			r/min	240	180	120	90	72	60	45	36	30	22.5
9BDG□ -200FWH	9WHD□-030	kgfcm	81.9	105.3	148.2	183.7	214.3	204.1	183.7	173.5	163.3	132.7	-
		N.m	8.02	10.32	14.52	18.00	21.00	20.00	18.00	17.00	16.00	13.00	-
	9WHD□-040	kgfcm	-	-	-	-	-	-	-	315.0	330.0	295.0	270.0
		N.m	-	-	-	-	-	-	-	30.88	32.35	28.92	26.47

50Hz

Motor Model	Gearbox Model	Gear Ratio	3	3.6	6	9	12.5	15	18	20	25	30	36	50	60	75	90	100	120	150	180	200	
			r/min	500	417	250	167	120	100	83	75	60	50	42	30	25	20	17	15	13	10	8	7.5
9BDG□ -200FH	9HBK□BH 9HFK□BH	kgfcm	37.4	44.8	74.7	112.1	140.6	168.8	202.5	204.0	255.0	300.0	300.0	300.0	300.0	300.0	300.0	300.0	300.0	300.0	300.0	300.0	300.0
		N.m	3.66	4.39	7.32	10.98	13.78	16.54	19.85	19.99	24.99	29.40	29.40	29.40	29.40	29.40	29.40	29.40	29.40	29.40	29.40	29.40	29.40

Motor Model	Gearbox Model	Gear Ratio	7.5	10	15	20	25	30	40	50	60	80	100
			r/min	200	150	100	75	60	50	37.5	30	25	18.75
9BDG□ -200FWH	9WHD□-030	kgfcm	94.5	121.5	171.0	183.7	214.3	204.1	183.7	173.5	163.3	132.7	-
		N.m	9.26	11.91	16.76	18.00	21.00	20.00	18.00	17.00	16.00	13.00	-
	9WHD□-040	kgfcm	-	-	-	-	-	-	-	350.0	330.0	295.0	270.0
		N.m	-	-	-	-	-	-	-	34.31	32.35	28.92	26.47

1) Enter the phase & voltage code in the box (□) within the motor model name.

2) Enter the gear ratio in the box (□) within the Gearbox model name.

3) A colored background indicates gear shaft rotation in the same direction as the motor shaft; a white background indicates rotation in the opposite direction.

4) The rotating speed is calculated by dividing the motor's synchronous speed (50Hz: 1,500r/min, 60Hz: 1,800r/min) by the gear ratio.

The actual speed is 2~20% less than the displayed value, depending on the size of the load.

B AC Motors

Brake Motor 200W (□90mm)

Dimensions

MOTOR ONLY

- MOTOR MODEL:
9BDD□-180F (GENERAL FAN)

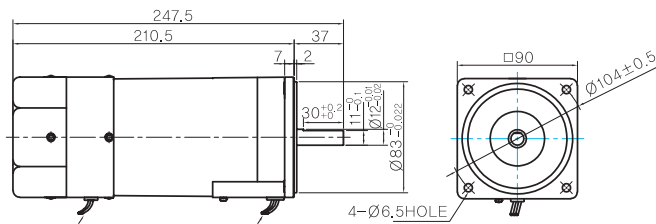

LEAD WIRE(Yellow) 300mm
UL STYLE NO,3398 AWG NO,22
380V OVER NO,3613 AWG NO,22

LEAD WIRE 300mm
UL STYLE NO,3271 AWG NO,22

MOTOR OUTPUT SHAFT

MODEL	SPEC
D-CUT TYPE	37 30±0.2 11±0.1 Ø12±0.03
9BDD□-200F	
KEY TYPE	37 25±0.2 Ø12±0.03
9BDK□-200F	

KEY SPEC

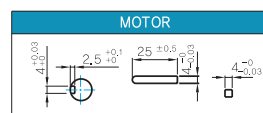

INTER-DECIMAL GEARBOX

- MODEL:
9XD10□□

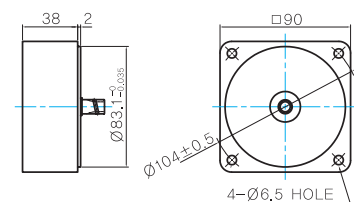

GEARED MOTOR

H TYPE GEARBOX

- MOTOR MODEL:
9BDG□-200FH (GENERAL FAN)

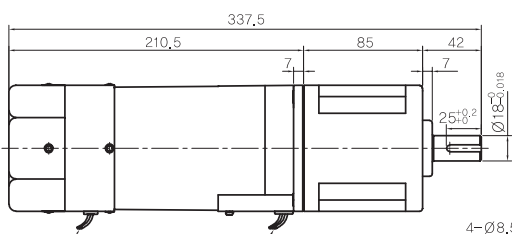

LEAD WIRE(Yellow) 300mm
UL STYLE NO,3398 AWG NO,22
380V OVER NO,3613 AWG NO,22

LEAD WIRE 300mm
UL STYLE NO,3271 AWG NO,22

- GEARBOX MODEL:
9HBK□BH

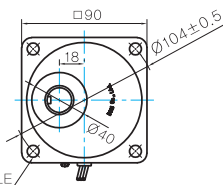

GEARBOX OUTPUT SHAFT

MODEL	SPEC
KEY TYPE	42 25±0.2 Ø18±0.08
9HBK□BH	
9HFK□BH	

- GEARBOX MODEL:
9HFK□BH

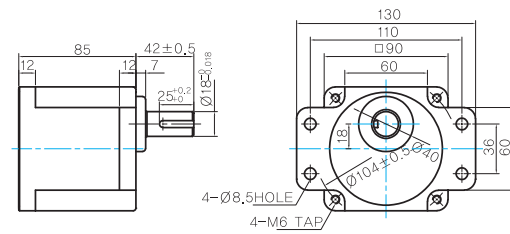

KEY SPEC

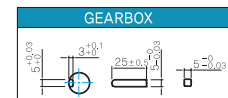

WH TYPE GEARBOX

- MOTOR MODEL:
9BDG□-200FWH (GENERAL FAN)

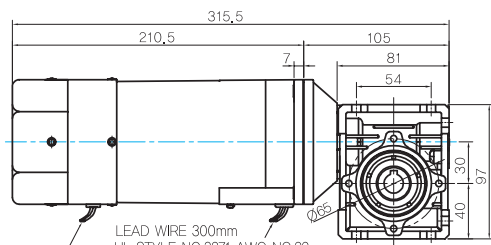

LEAD WIRE 300mm
UL STYLE NO,3271 AWG NO,22

LEAD WIRE(Yellow) 300mm
UL STYLE NO,3398 AWG NO,22
380V OVER NO,3613 AWG NO,22

- GEARBOX MODEL:
9WHD□-030

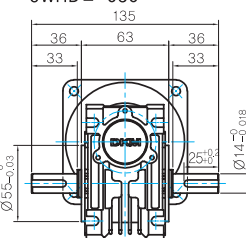

KEY SPEC

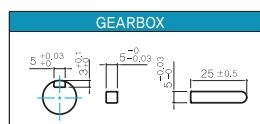

- SHAFT(Unidirectional, Bi-directional)

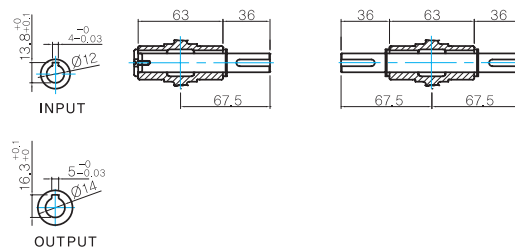

FLANGE

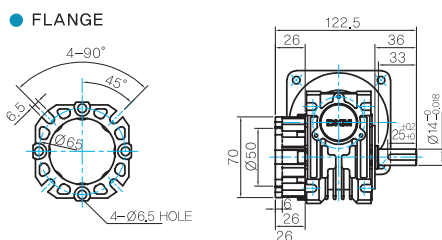

* The output flange and shafts are sold separately.

● MOTOR MODEL:
9BDG□-200FWH (GENERAL FAN)

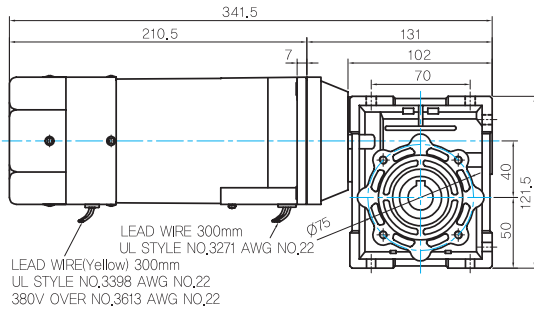

● FLANGE

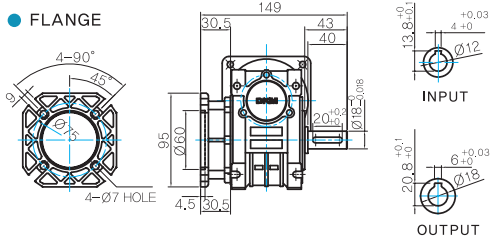

● GEARBOX MODEL:
9WHD□-040

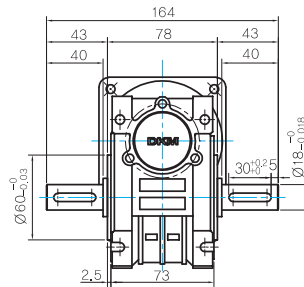

● KEY SPEC

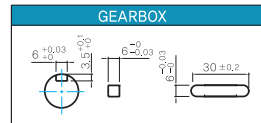

● SHAFT(Unidirectional, Bi-directional)

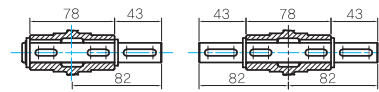

● WEIGHT

PART		WEIGHT(kg)
GEAR BOX	MOTOR	3,5
	9HB(F)K3BH ~ 9HB(F)K9BH	1,45
	9HB(F)K12.5BH ~ 9HB(F)K18BH	1,5
	9HB(F)K20BH ~ 9HB(F)K60BH	1,7
	9HB(F)K75BH ~ 9HB(F)K200BH	1,8
	9WHD□-030	1,13
9WHD□-040	2,2	
9XD10□□	0,5	

* The output flange and shafts are sold separately.

Connection Diagrams

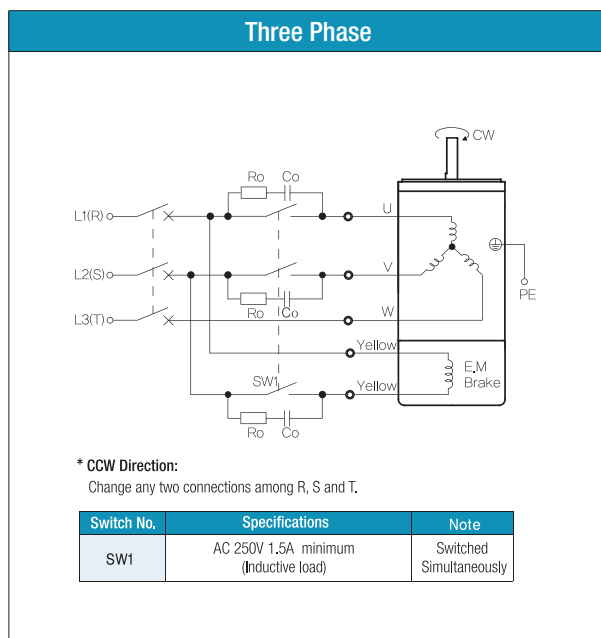

Motor Images

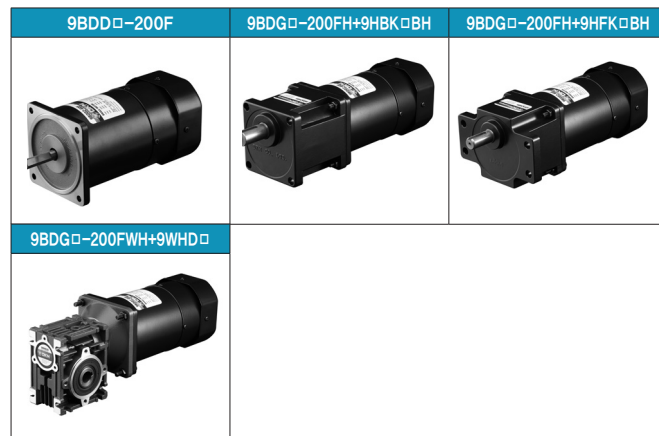

- 1) The direction of motor rotation is as viewed from the shaft end of the motor.
- 2) CW represents the clockwise direction, while CCW represents the counterclockwise direction.
- 3) SW1 operates both motor and electromagnetic brake action.
- 4) The electromagnetic brake will be released and the motor will rotate when SW1 is switched simultaneously to ON. When SW1 is switched simultaneously to OFF, the motor stops immediately with the electromagnetic brake and holds the load.
- 5) If you wish to release the brake while the motor is stopped, apply voltage between the two brake lead wires (yellow).
- 6) Ro and Co indicate CR circuit for surge suppression. [Ro=5~200Ω, Co=0.1~0.2μF, 200W (400W)]